



# USER MANUAL



# Table of Contents

---

<b>Product Description</b> .....	01
Product features .....	01
Main function .....	01
Product application .....	01
Main specifications .....	01
<b>Notice before Operation</b> .....	02
Safety Precautions .....	02
Precautions of disc application .....	03
Machine maintenance .....	03
<b>Basic Operation</b> .....	04
Schematic diagram of remote controller .....	04
Functional description of remote controller .....	05
Description of Ports .....	06
Description of functions at the front panel .....	07
<b>OSD Operation</b> .....	09
Main Menu .....	09
USB/DISC/SD OSD .....	10
Radio function .....	10
PHONE OSD .....	11
Bluetooth function .....	11
Bluetooth interface Keys .....	12
IPOD function .....	13
TV function .....	14
System Setup .....	15
Display Setup .....	16
Sound Setup .....	17
Navigation path setup .....	18
<b>Troubleshooting</b> .....	24

## • Product Description •

---

### Thank you for your using our product!

Thank you for using our product, and hopefully you can understand the product operation method conveniently and easily through the manual. Please read the manual carefully before use so as to operate the product safely and enjoy better amusement.

### Main Functions

1. 7 /6.2 -inch 16: 9 TFT high resolution LCD screen.
2. Built-in radio, DVD player, etc..
3. Compatible with DVD/VCD/CD/WMA/JPEG, etc..
4. High sensibility FM/AM reception, can save 30 stations.
5. 3D graphic touch interface, all the functions can be realized through touch operation.
6. Built-in GPS intelligence navigation system (optional).
7. Built-in Bluetooth function, with handwritten + touch input functions.
8. Optional ipod control, can be operated by touch screen.
9. Connectable with parking sensor.
10. Two-way video output, Four-way audio output.
11. Auxiliary input function, optional external audio/video input.
12. With USB interface, supporting audio play and picture browse.
13. Auto identification of NTSC/PAL system.
14. 4×45 W high fidelity and high power output.
15. Digital TV Function(Optional)
16. Real time clock display function.
17. 3G connection ready(visit [www.echowin.com](http://www.echowin.com) for more details)

### Product Application

The product adopts high resolution TFT touch LCD, can play majority of discs currently available in the market, provides functions such as navigation (optional), radio, analog TV, Bluetooth and visible reversing radar, and high fidelity power output, etc., extensively used in various cars, special purpose vehicles and buses, etc. with 1-DIN dimensions.

### Main Specifications

Power voltage: 9.5-16V

Max. current: 15A

## • Notice before Operation •

### Safety Precautions



Please read all instructions in detail before installation, and it is recommended that the machine be installed by automobile sound profession sales agent.

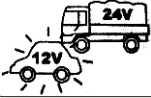

The machine is applicable to car 12 V power supply system (requiring grounded wire). Please don't install the machine directly on the truck or bus with 24 V power. Otherwise, it may damage the machine.



Please use licensed discs, don't use inferior discs or nonstandard discs, otherwise it may cause machine failure or affect service life.



Never replace the fuse for power supply without instructions from professional personnel, using an improper fuse may cause machine damage and cause fire.



In order not to breach the traffic regulations, the driver should not watch the program and operate the machine while driving to prevent unnecessary traffic accident.



For safety and to ensure product normal application, please invite professional personnel from the sales dealer of the product to install. Never disassemble or repair the machine by yourself to prevent machine damage and accident. For detail, please consult with the local distributor of professional automobile sound system.



Please don't place the product in a damp environment and in water to prevent electric shock, unnecessary damage and fire due to short circuit.

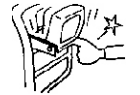

The mechanic driving part of the product display screen adopts full-automatic precise driver assembly. Never push, pull and rotate the machine with strong force by hand and never bump the TFT display to prevent product damage.



For a safety drive, please keep the volume as low as possible for the purpose of the noting traffic and road surface condition.



Never insert foreign article into the disc loading mechanism.



The product is a laser product; therefore, please don't aim the laser beam to the eyes directly.



Note: To prevent short circuit, please remember turning off the automobile and disconnecting ACC and B+ before installation.

## • Notice before Operation •

### Precautions of Disc Application

- The machine supports 12 cm disc only, never insert 8 cm disc into the machine. Don't use adaptable accessory when inserting 12 cm disc, otherwise, the disc may not be removed from the machine.
- Don't expose the disc under direct sunlight. It must be put in the box. Otherwise, the disc may deform and can't be used normally.
- Don't use cracked or deformed disc. Otherwise, it may lead to a failure.
- Please don't use disc with adhesive such as prismatic glass membrane and rental identification, etc. If such disc is played in the player, it may be hard to take out, and it may lead to a failure.
- Don't use an irregular disc. Otherwise, it may cause machine damage.
- Please not use a disc with transparent or translucent data surface since it can't be inserted into, taken out or played normally.
- While using a new disc, there may exist bur at the inner and outer edges of the disc. If so, use a ball-point pen, etc. to clear it away. Otherwise, the bur may adhere to the disc's playing surface, resulting in jitter.

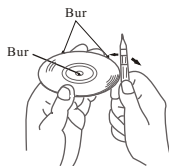

- Don't touch a disc's playing surface (sending out colorful iridescence). Otherwise, fingerprint may be left on the disc surface, resulting in jitter phenomena.



- If a disc with dirt is played, it may result in the disc score or jitter. If a disc is dirty, it may be cleaned with disc cleaning agent sold on the market, and it can be wiped out lightly from the inner disc outward.



### Machine Maintenance

- Use soft cloth to clean dirt (silicone resin cloth, etc.). When it is very dirty, it is required to use a piece of cloth soaked with diluted kitchen cleaning agent and wipe it after wringing the cloth dry. Then wipe it with a piece of dry cloth. The LCD screen is easy scoring, so, please wipe it carefully. While adopting the chemical dish cloth, please wipe it as per the Operation Manual.
- Don't use volatile agent such as benzene or sparse agent, etc. Otherwise, it may be deteriorated or the lacquer on it may shed off.

## Schematic diagram of remote controller

Note: Please take off the battery plate before using the remote control.

### 1. Remote Control Buttons











### 2. Function Instruction

- ⏻ Power on/off: press once to turn on/off.
- MUTE Button: Mute function.
- MODE switch button: Press once to switch to Radio/DVD/AUX/TV/GPS.
- ▲ Eject button.
- DVD Button: press this button direct to enter DVD mode.
- STOP Button.
- VOL+/VOL- button.
  - ▶▶ Play/pause button.
- GPS Navigation Button.
  - ◀▶ In the radio to the low / high-frequency semi-automatic search radio stations, in the player when the song / next song (chapter).
- OK confirm button.
- TV Button.
- BAND Radio button.
- AUDIO switch button, on TV mode to switch audio, on DVD TO switch left/right sound.
- 0.1.2....10+ Select the current band. Chapters. Preset radio stations, enter the number Button.
- GOTO Search type player.
- RPT Repeat Button.

## ● Basic Operation ●

### Functional description of remote controller

1. : Power key.
2. MOD: switch mode.
3. : DVD load in and out.
4. : Mute ON/OFF.
5. AMS: browse function at radio mode, auto search at TV mode.
6. PU/LOC: Set up local/remote search under radio mode.
7. ST: Set up stereo/mono under radio mode.
8. BAND: Band FM1/FM2/FM3/AM1/AM2; AUTO/NTSC/PAL system switch at DVD; System switch at TV.
9. VOL-: Decrease volume.
10. L/R: switch track when playing VCD at DVD mode, language selection when playing DVD.
11. VOL+: Increase volume.
12. PBC: PBC function under DVD mode.
13. RPT: Set up repeat play function under DVD mode.
14. PD/RDM: Set up random play function under DVD mode (requiring disc support).
15. SCAN: browse at CD/VCD mode.
16. PROG: Programming play function under DVD mode.
17. Numeric key: 0~9
18. If the digital input exceeds 10 under DVD mode, it is required to press respectively two numeric keys, e.g.: 1 and 2, meaning 12.
19. DEL: Clear function under Bluetooth mode.
20. : Stop play function under DVD mode.
21. : Play/Pause switch function under DVD mode.
22. GOTO: Selecting function under DVD mode.
23. SUB-T: Subtitle function (requiring disc support) under DVD mode.
24. MENU: Enter/Exit menu setup under DVD mode.
25. : Menu operation direction key.
26. ENTER: Menu operation confirmation key.
27. EXIT: Exit the current status, and enter the main menu.
28. OSD: Display OSD information under DVD mode.
29. ZOOM: DVD image zoom.
30. ANGLE: Angle switch function under DVD mode (requiring disc support).
31. SLOW: Slow play function under DVD mode.
32. TITLE: Display title menu under DVD mode.
33. : Screen UP/DOWN, used to adjust the view angle.
34. : Long press for manual station search function under radio mode. Short press for auto search function; Previous/Next chapter when playing DVD.



**Description of Ports**

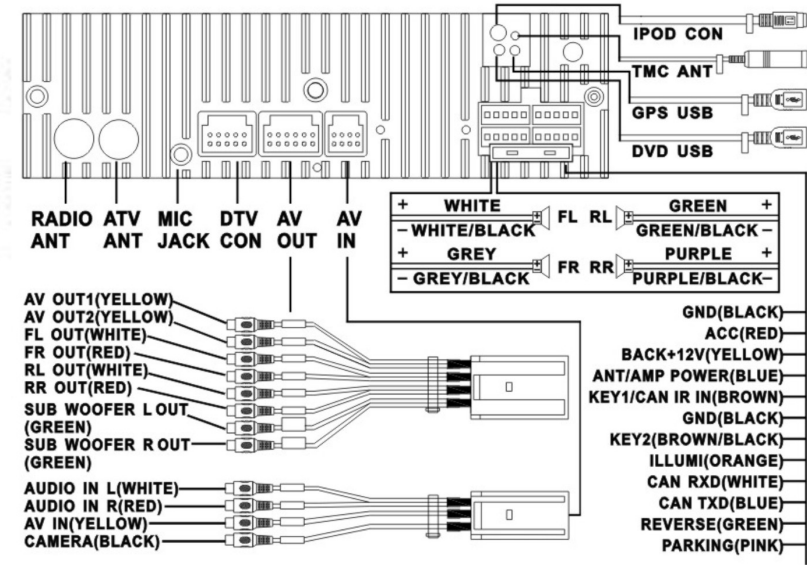

**Description of function, color and location of leading line :**

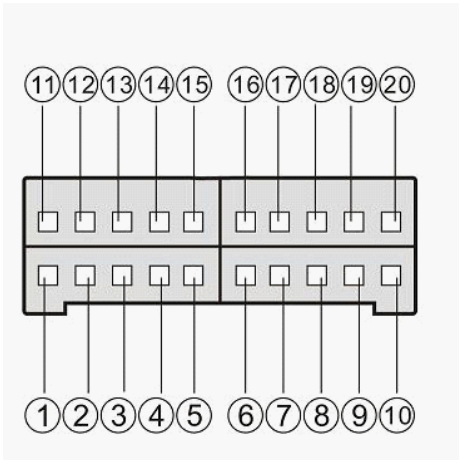

- 1、 Yellow — B+(Battery positive)
- 2、 Blue — Auto-ANTI(Amplifier control)
- 3、 Brown — SWC Key 2
- 4、 Black — SWC GND
- 5、 Green — SWC Key 1
- 6、 Orange — Illumination
- 7、 White — UART RXD
- 8、 Blue — UART TXD
- 9、 Pink — Reverse
- 10、 Purple — Brake
- 11、 Black — GND(Ground)
- 12、 Red — ACC
- 13、 Green/Black — RL-(rear left speaker negative)
- 14、 Green — RL+(rear left speaker positive)
- 15、 Purple/Black — RR-(rear right speaker negative)
- 16、 Purple — RR+(rear right speaker positive)
- 17、 White — FL+(front left speaker positive)
- 18、 White/Black — RL-(front left speaker negative)
- 19、 Grey — FR+(front right speaker positive)
- 20、 Grey/Black — FR-(front right speaker negative)

## ● Basic Operation ●

### Description of functions at the front panel

#### DVN-E39



- 1, DISC Input.
- 2, RADIO: Radio mode.
- 3, BAND: radio-band conversion.
- 4, Radio station select.
- 5, SRC: different functions for switch mode.
- 6, NAVI: GPS menu.
- 7, Power switch/Volume: Press it by 3s to power off. Press it one time for switching from Btrightness, Contrast, Color, BASS,TREBLE,MIDDLE adjustment . Rotating for volume increasing/decreasing. Press it one time for power on0
- 8, Reset button.
- 9, SD card slot: The upper for GPS, the lower for multimedia0
- 10, Disc access keys.
- 11, Mute: mute button.
- 12, 'Rlay/pause0
- 13, Rearward button.
- 14, Forward button.
- 15, TEL: Bluetooth receive.
- 16, DVD: DVD mode0
- 17, Pick up.
- 18, Hang up.
- 19, Pick up; Rotating in media mode for previous/next0

Description of functions at the front panel

DVN-E46



1,DISC Input.

2,Play/pause.

3,BAND:radio-band conversion.

4,MUTE:Mute button----Long press to dimm the screen.

5,MODE:different functions for the switch mode.

6,Power switch/Volume: Press it by 3s to power off. Press it one time for switching from Btrightness,Contrast, Color, BASS,TREBLE,MIDDLE adjustment . Rotating for volume0

7,MIC:this for bluetooth audio input hole.

8,SD card slot for GPS/music/picture...media.

9,Disc access keys.

10,Forward button.

11,Rearward button.

12,GPS menu----Long press to mute background audio while listening android/wince music.

13,Bluetooth receive/Manual tuning,When the radio frequency tuning,DVD for fast forward/slow motion.

14,IR:Remote window.

15,USB interface.

# • OSD Operation •

## Main Menu



1. DISC touch key  
Touch lightly the key to enter DISC status. (For relevant operation, refer to DVD operation interface).
2. RADIO touch key  
Touch lightly the key to enter radio status. (For relevant operation, refer to radio operation interface).
3. IPOD touch key (without IPOD, no IPOD status)  
Touch lightly the key to enter IPOD status. (For relevant operation, refer to IPOD operation interface).
4. PHONE touch key (optional)  
Touch lightly the key to enter PHONE (BT) status. (For relevant operation, refer to PHONE operation interface).
5. CAMERA touch key  
Touch lightly the key to enter camera status. (For relevant operation, refer to camera operation interface).
6. AUX touch key  
Touch lightly the key to enter AUX status. (For relevant operation, refer to AUX operation interface).
7. SD touch key  
Touch lightly the key to enter SD card status. (For relevant operation, refer to SD operation interface).
8. NAVI touch key  
Touch lightly the key to enter NAVI card status. (For relevant operation, refer to NAVI operation interface).
9. TV touch key  
Touch lightly the key to enter TV status. (For relevant operation, refer to TV operation interface)
10. USB touch key (without USB, no USB status).  
Touch lightly the key to enter USB status. (For relevant operation, refer to USB operation interface)
11. SETTING touch key  
Touch lightly the key to enter parameter setup. (For relevant operation, refer to parameter setup of operation interface)

Slide from left to right/right to left on touch screen to rotate the icons.

## • OSD Operation •

### USB/DISC/SD OSD



#### Interface keys:

1. Touch 1 key lightly to fast reverse.
2. Touch 2 key lightly to fast-forward.
3. Touch 3 key lightly for previous track.
4. Touch 4 key lightly for next track.
5. Touch 5 key lightly to switch between play and pause position.
6. Touch 6 key to start repeat play; Press the key again for normal mode.
7. Touch 7 key to start random play; Press the key again for normal mode.
8. Touch 8 key to return to the main menu0
9. Touch 9 key to enter the general setup page.
10. Touch 10 key to maximize window.
11. Touch 11 key to switch on the number keyboard.

### RADIO



## • OSD Operation •

1. Touch **1** key to switch among FM1, FM2, FM2, AM1 and AM2.
2. Short touch **2** key to search manually upward in single step for station.  
Long touch **2** key to search upward automatically.
3. Short touch **3** key to search manually downward in single step for station.  
Long touch the key to search downward automatically.
4. Touch **4** key to turn on/off the AF function.
5. Touch **5** key to turn on/off the PTY function.
6. Touch **6** key to turn on/off the TA function.
7. Touch **7** key to return to main interface.
8. APS touch key  
Long touch the key (>2s), it will scan the whole frequency bands, and will save the stations searched to M1-M6. Short touch the key (<1s) to browse play the station saved, and each station will pre-play 5 seconds.

**NOTE: Save radio station name instead of frequency.**

**When station name appear on the screen, long press the corresponding frequency to save the radio station name instead of radio frequency.**

## PHONE OSD



## Bluetooth function:

- A. The system provides Bluetooth hands free communications function (for the first time connection) if your cellular phone has Bluetooth function. It can create point-to-point connection of system, and it can carry out functions such as calling and answering, etc. on the screen. The operation is as follows0

## • OSD Operation •

---

B

1. Switch on Bluetooth function

Touch lightly Bluetooth icon of main menu to enter Bluetooth menu, and switch on the Bluetooth function of your cellular phone in the meantime.

2. Pairing

Switch on searching new equipment function of the cellular phone. After the system link the cellular phone. There will be a prompt in the cellular phone “CONNECT EQUIP?” The cellular phone selects “YES” and enter password “0000” to confirm he binding. After the system and cellular phone are connected, the screen will display “CONNECT OK”. Otherwise, please retry until the link is successful.

3. Make a call

Enter the Bluetooth mode, and you can enter telephone number through the numeric key of the screen. You can also dial the number directly through the cellular phone. After pressing the pick up key, the system will convert the voice from cellular phone to car-bone speaker system, and you will hear the dial tone and the other party’s voice through the speaker in the automobile. After the connection is completed, press the red hang pick up key or hang up through the cellular phone directly.

4. Answer a call

When there is an incoming call, the system will switch to the Bluetooth hands free Function automatically under any mode, and convert the play voice mute of original mode to incoming ring and press the key to select answer or reject.

### Bluetooth interface Keys:

1. Touch 1 key to hang up the cellular phone directly.
2. Touch 2 key to switch between hand free and mobile.
3. Invalid.
4. Touch 4 key to mute.
5. Touch 5 key to stop play in A2DP.
6. Touch 6 key for previous track in A2DP.
7. Touch 7 key, the player will switch between play and pause position in A2DP.
8. Touch 8 key for next track in A2DP.
9. Touch 9 key to enter previous page.
10. Touch 10 key to delete number.
11. Touch 11 key to pair with cellular phone.

## • OSD Operation •

### IPod operation instruction

Press the IPOD button on the main menu to enter the iPod model (please make sure the iPod is connected correctly)0

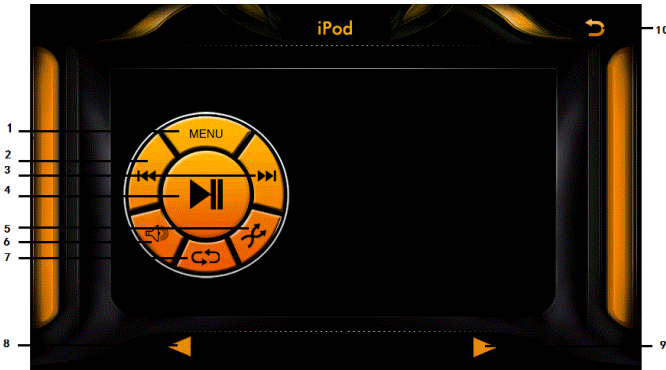

1. MENU Key  
Touch 1 key for menu play0
2. PREVIOUS (⏮) touch key  
Short touch the key for previous track0
3. NEXT (⏭) touch key  
Short touch the key for next track0
4. PLAY/PAUSE (⏯) touch key  
Touch lightly the key for play and pause function.
5. RDM touch key  
Touch 5 key to start random play; Press the key again for normal mode.
6. MUTE touch key  
Touch 6 key to switch ON/OFF the volume0
7. RPT touch key  
Touch 7 key to start repeat play; Press the key again for normal mode.
8. Touch 8 Key to switch to the previous page of iPod menu.
9. Touch 9 Key to switch to the next page of iPod menu.
10. EXIT  
Touch this key to return to main menu.



## • OSD Operation •

### TV function

1	2	3	FAV	MENU
4	5	6	SCAN	ESC
7	8	9	↑	ENTER
0	INFO	←	↓	→

### DTV

1. INFO touch key  
Touch INFO key to show the information of current station.
2. FAV touch key  
Touch FAV key to show the FAV station.
3. Menu touch key  
Touch MENU key to enter the menu of digital TV.
4. SCAN touch key  
Touch SCAN key to automatic scan and save.
5. ESC touch key  
Touch ESC key to exit the current menu.
6. Enter touch key  
Touch ENTER key to confirm0
7. Touch LEFT/RIGHT key to decrease/increase volume.
8. Touch UP/DOWN key to select the station.

### ATV

1. SCAN touch key  
Touch SCAN key to automatic scan and save.
2. Enter touch key  
Touch ENTER key to switch the analog TV mode among the PAL/SECAM/NTSC.  
Touch LEFT/RIGHT key to decrease and increase volume.
3. Touch UP/DOWN key to select the station.

## System Setup

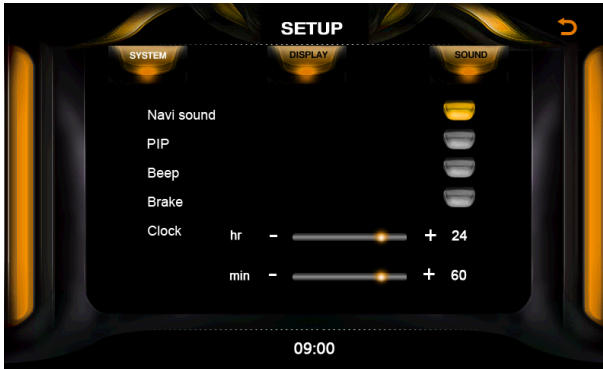

### 1. Navi Sound Key

Touch “” key to select “on” and “off”.

On: navigation sound comes out from front speaker while music comes out from rear speaker.

Off: All speakers comes out navigation sound, music comes out after navigation sound stop0

### 2. PIP Key

Touch“”key to select “on” and “off”.

On: make background image/video show on navigation mode.

OFF: make PIP OFF.

### 3. Beep Key

Touch“”key to select “on” and “off”.

On: Beep when press on button or touch screen.

Off: no sound when press on button or touch screen.

### 4. Brake Key

Touch“”key to select “on” and “off”.

On: Need to connect the parking cable to parking gear to watching movie and TV when parking0

Off: watch movie and TV while driving.

### 5. Clock key

Click — and + to set the time.

### 6. RETURN touch key

Touch the key to enter previous page.

## Display setup

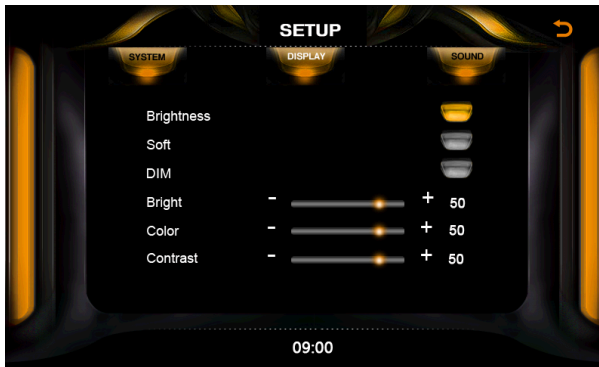

1. Brightness Key

Touch “” key to select “Bright”.

2. Soft Key

Touch “” key to select “Soft”.

3. DIM Key

Touch “” key to select “on” and “off”.

On: Reduce the brightness of screen by long pressing the Mute button.

Off: turn off screen by long pressing the Mute button.

4. Bright key

Click — and + to set the Brightness.

5. Color key

Click — and + to set the Color.

6. Contrast key

Click — and + to set the Contrast.





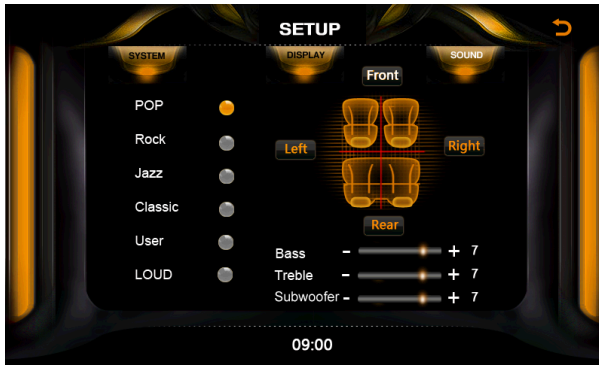

7. RETURN touch key

Touch the key to enter previous page.

## • OSD Operation •

### Sound setup



1. POP Key Touch “” key to select “POP”
2. Rock Key Touch “” key to select “Rock”
3. Jazz Key Touch “” key to select “Jazz”
4. Classic Key Touch “” key to select “Classic”
5. User key Touch “” key to customization by user.
6. LOUD key Touch “” key to select LOUD “on” and “off”

7. Front key

Balance setting for increasing front speaker sound.

8. Rear key.

Balance setting for increasing rear speaker sound.

9. Left key

Balance setting for increasing left speaker sound.

10. Right key

Balance setting for increasing right speaker sound.

11. Bass key

Click “+” and “-” in the menu to adjust Bass.

12. Treble key

Click “+” and “-” in the menu to adjust Treble.

13. Subwoofer key

Click “+” and “-” in the menu to adjust Subwoofer.

14. RETURN touch key

Touch the key to enter previous page.

### PIP operation

Turn on PIP option in system setting menu to have PIP function in navigation mode

Press SRC or MODE key on front panel to switch the background source.

Put touch pen on the small window of the navigation mode to move its position

### Factory Setting

Press “9” on IR remote controller in AUX mode to enter factory setting mode

If the car have factory amplifier to make the sound too loud, select the AMP option to “Normal”

# • OSD Operation •

## Navigation path setup



Press the GPS icon of the main interface, then appear below interface:

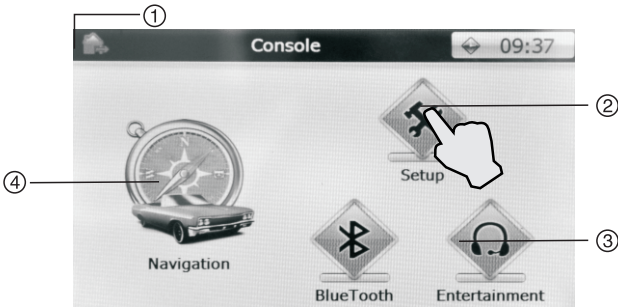

- 1).Back icon:press it to go back to main interface(it only effect when you press it 3 seconds after it entering any modes.
- 2).Setup Icon:Press it to enter into setup interface.
- 3).Entertainment function icon:press it into navigation interface.
- 4).Navigation function icon:press it into navigation interface.

Press the "setup" icon on the console interface,then appear the below interface

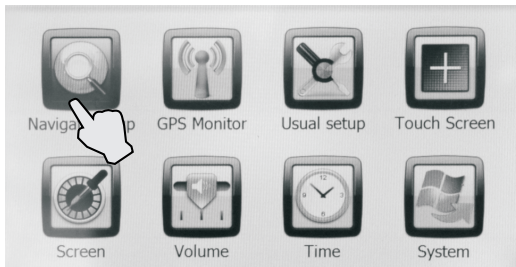

## • OSD Operation •

Press the "navigation setup" icon on the setup interface to enter into the below interface:

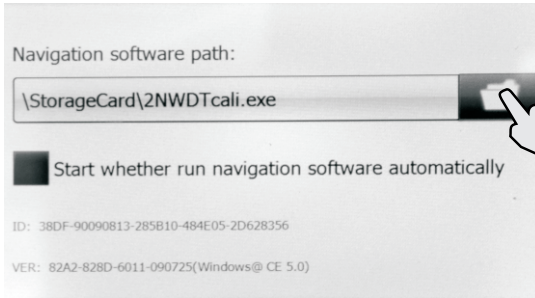

Press the "file folder" icon on the "navigation setup" interface to enter into below picture, and choose the map software on the picture.



Press the OK button, then you successfully set up the navigation path. Then touch the back button to return to the console interface.

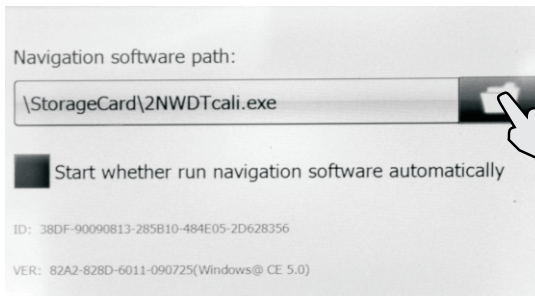

## • OSD Operation •

Press the "GPS monitor" icon to enter into below interface, it will display any kinds of information of GPS.



Touch the "General setup" icon to enter into below interface, then you can set up the language and the selection of effect for switch.

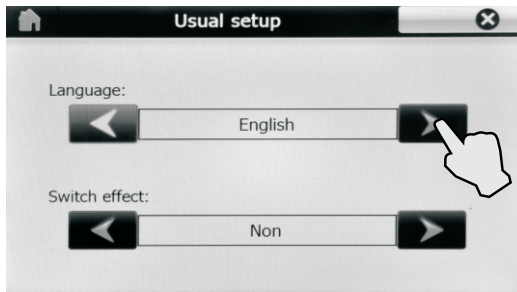

Touch the touchscreen icon to enter into below interface to adjust the screen.



## • OSD Operation •

Touch the screen icon to enter into below interface,then you can setup the brightness,position and magnitude of the screen.

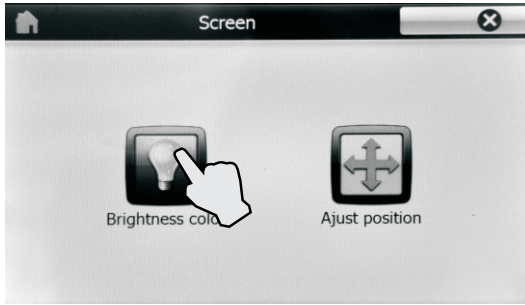

Touch the volume icon to enter into below interface,then you can setup the volume for system system voice and press voice.

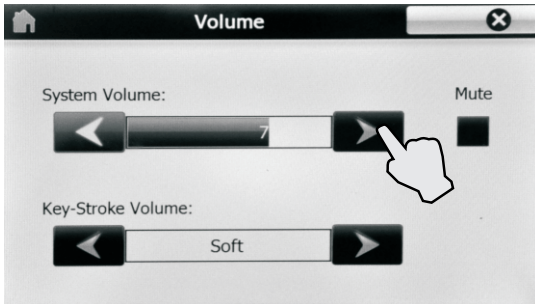

Touch the time icon to enter into below interface,then you can set up the time.

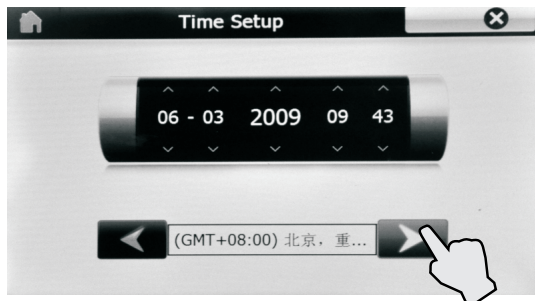



## • OSD Operation •

Touch the system icon to enter into below interface, it will display the version number, the memory capacity and the details. What's more, you can operate the initial setup and file fixing.

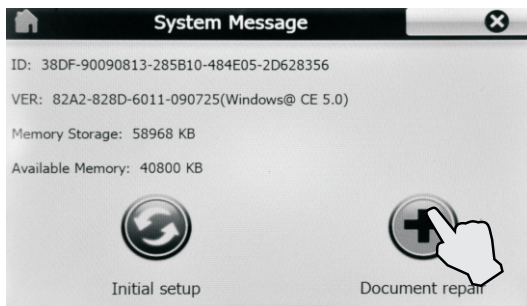

Touch the entertainment icon in the console interface, it will appear below picture.

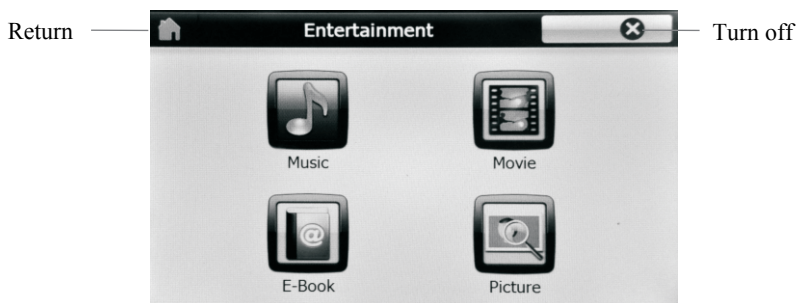

Touch the Music icon to enter into below picture.

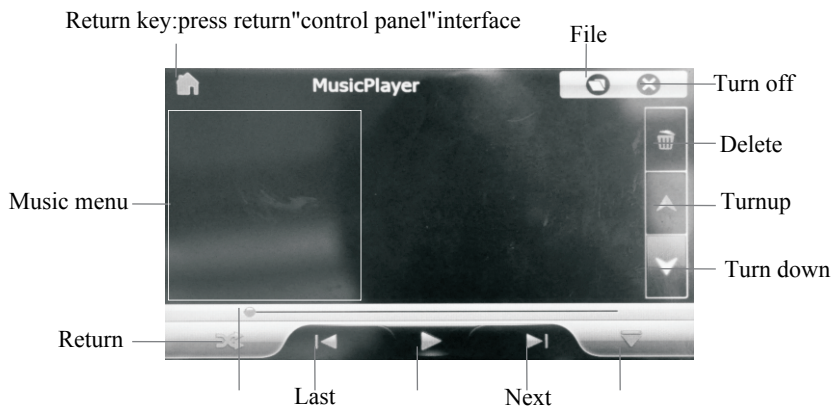

# • OSD Operation •

Touch the Movie icon to enter into below picture



Return key:press return "control panel"interface.

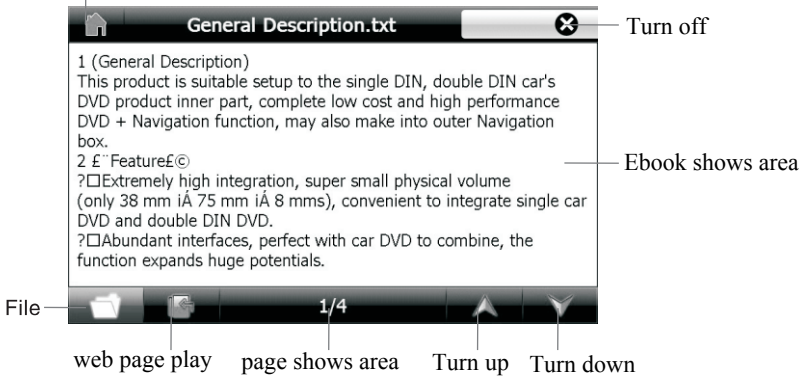

Touch the picture icon to enter into below picture.

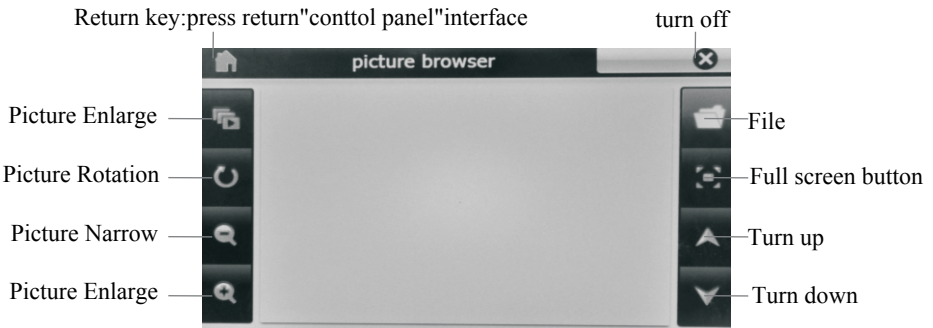

## • Troubleshooting •

Symptom	Possible Reason	Remedy
Routine		
Can't be started.	The fuse of machine power supply or the fuse of automobile battery is fused. The power voltage exceeds the rating scope. of work, the system protects automatically. The failure is caused by illegal operation.	Replace the fuse of right specifications. Adjust the voltage. Press the reset key at front panel to reset the system.
No sound output or small output volume	Incorrect connection line. Volume setup is too small. Speaker failure. Volume balance setup deviated too much. Speaker connection line partially grounded.	Check and correct the connection. Increase the volume. Replace the speaker. Adjust volume balance setup to middle position. Speaker connection lines should all be insulated.
Remote controller no function.	Battery already exhausted. Wrong battery installation.	Replace with new battery. Install the battery again.
Poor sound quality, with sever distortion	Please don't use inferior disc. Power impedance of speaker and machine not matched. Speaker open circuit.	Use licensed disc. Replace with a suitable speaker. Check speaker connection line.
Machine auto-reset when power off	ACC and B+ connection incorrect	Check for correct connection.
Rollover screen (optional)		
Without image	Brake connection line incorrect Non-brake status	Check for correct brake connection. Park the car in a safe place and remain brake status.
Image output abnormal	DVD current system video setup not cooperative Video signal connection incorrect	Adjust system video setup. Check and connect correctly.
Image pulled, stretched or compressed	Improper image proportion setup	Use correct image proportion setup.
Radio		
Weak reception signal	Auto antenna didn't stretch out completely. LOC function placed at ON status.	Connect auto antenna correctly. Switch off LOC function.
Read disc/card		
Break in the play process	Disc is dirty or damaged. File or record is damaged.	Clean or replace disc. Replace disc or re-select saving file.
Play information with mistake display	The information content is more than the screen can display.	
Mistake or not working	Illegal operation	Press down and hold JECT key 5s to reset read disc apparatus.
Disc can't enter	There is already disc in the machine.	Take out the disc inside the machine and load another disc.
The disc can't work normally.	The grade of disc exceeds that of lockup function. The district code of disc not compatible The disc is loaded upside down.	Adjust the setup grade of lockup function. Use compatible disc for the machine. When inserting disc, the face with tag heading up.
The SD card can be read on the computer, but not on the machine.	Because of SD card compatibility, not every SD card can be read in the system.	Replace the SD card.
Without repeat and search function when playing VCD	PBC function is under operation.	Switch off PBC function.

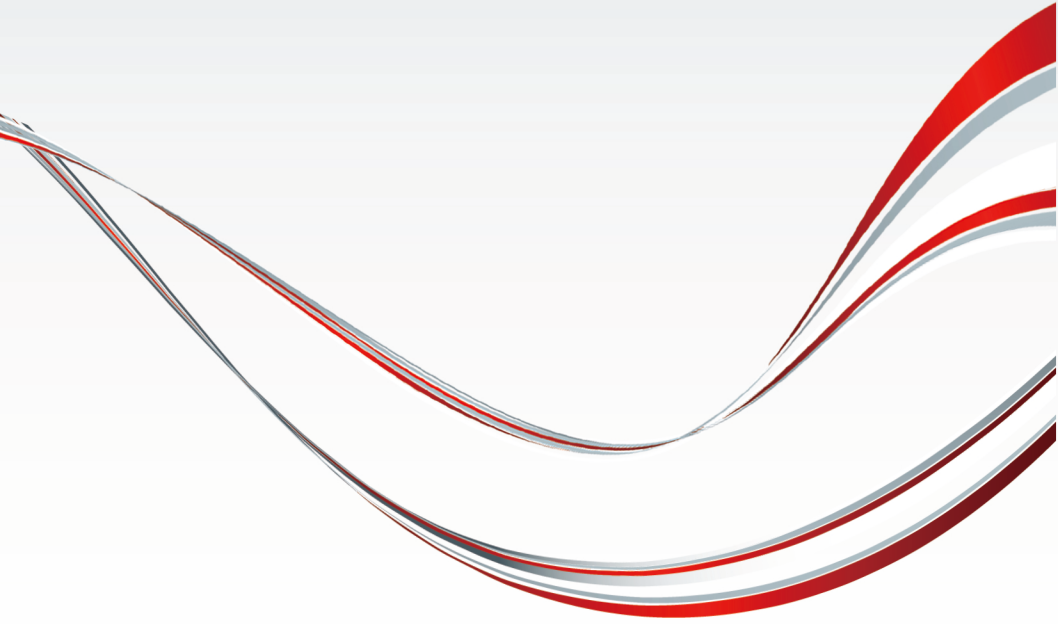

User Manual